

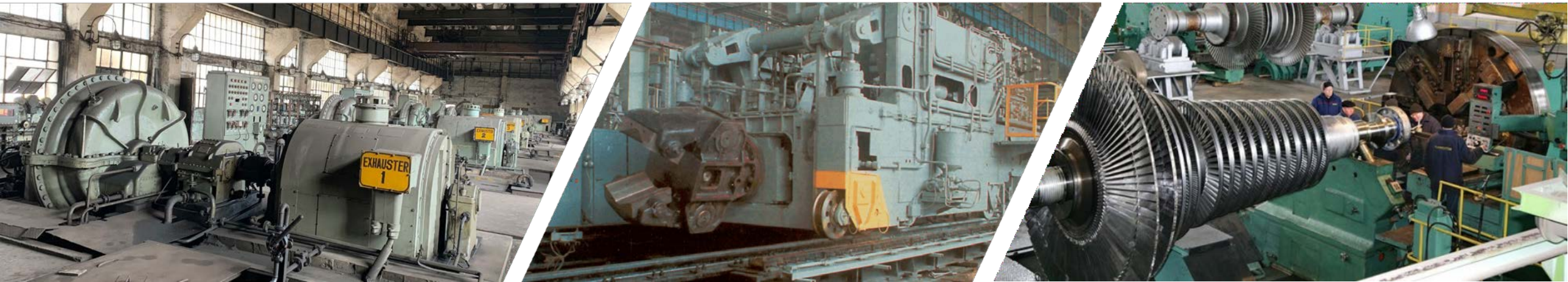

RELAYEXPORT

EQUIPMENT FOR INDUSTRIES





OUR HISTORY

- “Firm “Relayexport” LTD more than 30 years supplies OEM industrial equipment, provides engineering, mounting, maintenance, service, repairing, retrofit, modernization and other associated services by an experienced OEM staff, ensure warranty and post-warranty services and OEM spare parts supplying.
- The product line includes electrical and mechanical equipment and related products for power plants, steel plants, railway transport, shipbuilding, industrial machine building plants etc.
- We fulfill a wide range of export – import operations and have tight relations with CIS and EU producers. We have got long term experience in cooperation with former USSR built enterprises in India, Egypt, Iraq, Iran, Ethiopia, Vietnam and other countries.

MECHANICAL EQUIPMENT & SPARE PARTS

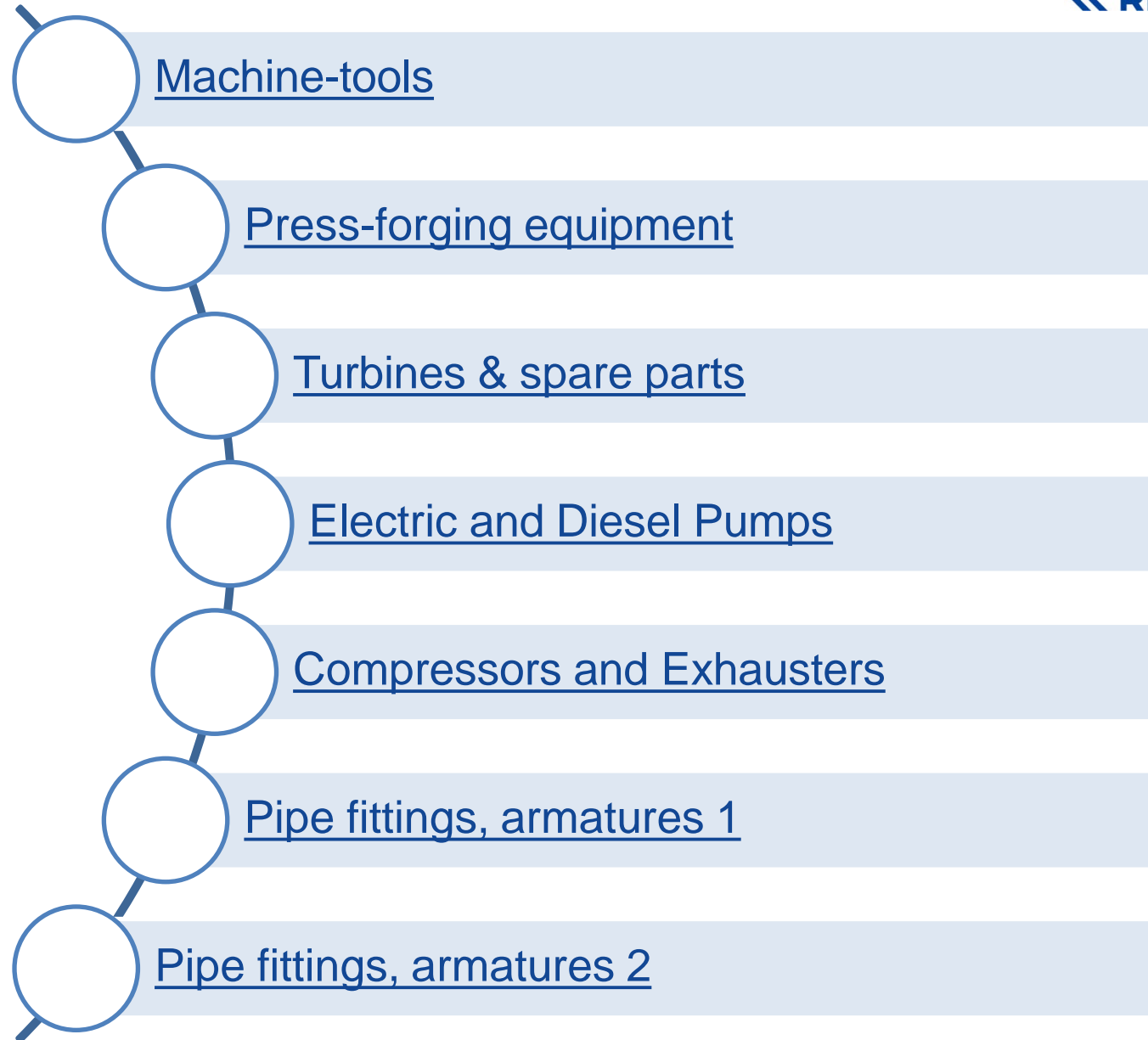

MECHANICAL EQUIPMENT & SPARE PARTS

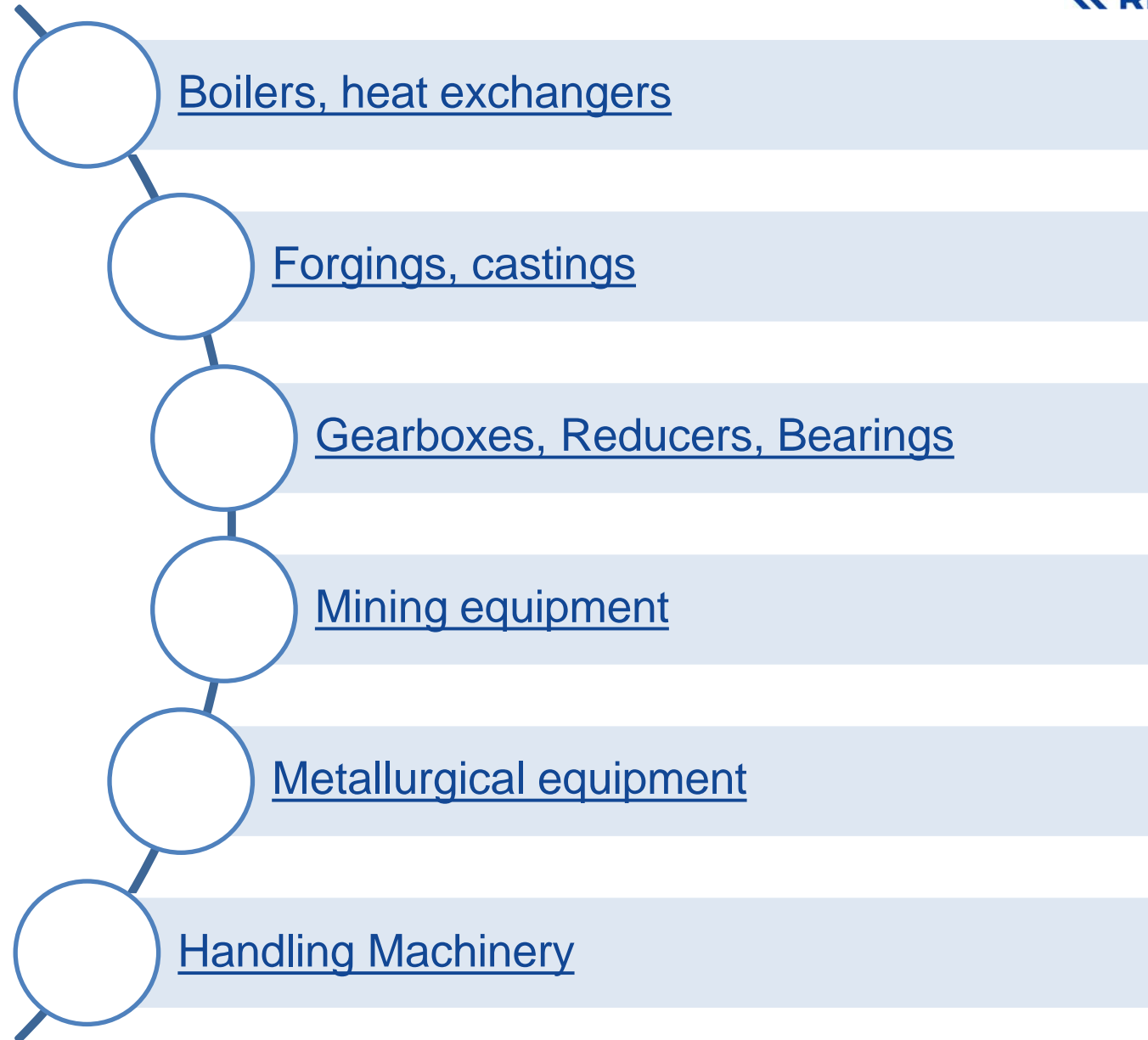

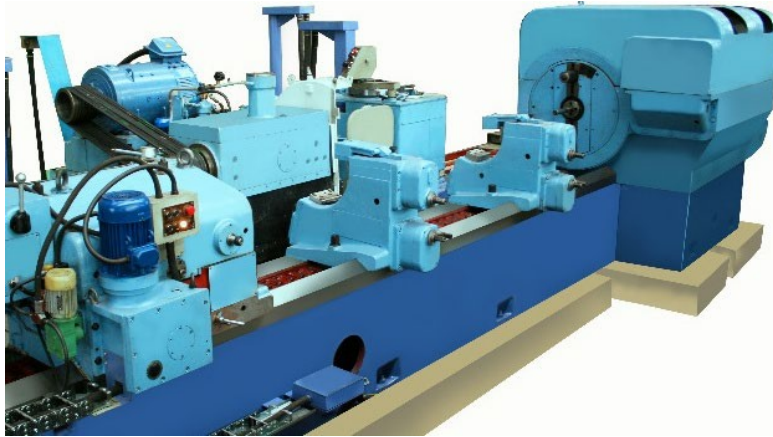
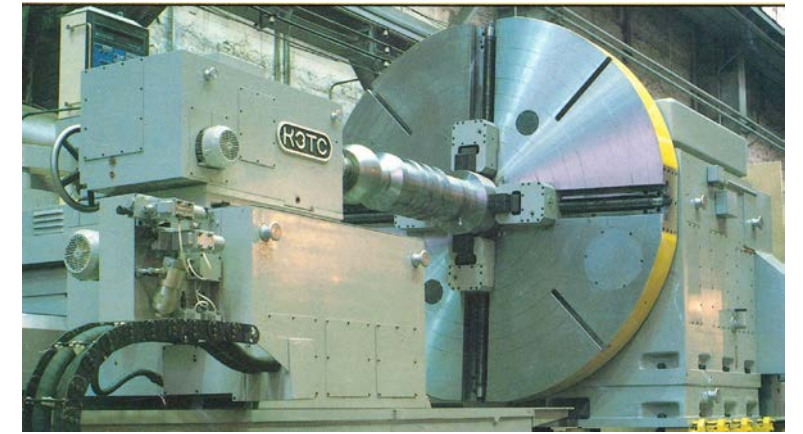
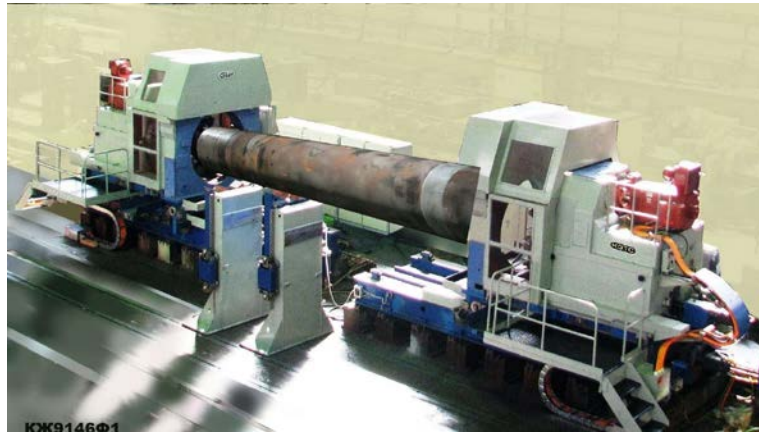

Machine-tools





Press-forging equipment





Turbines & spare parts



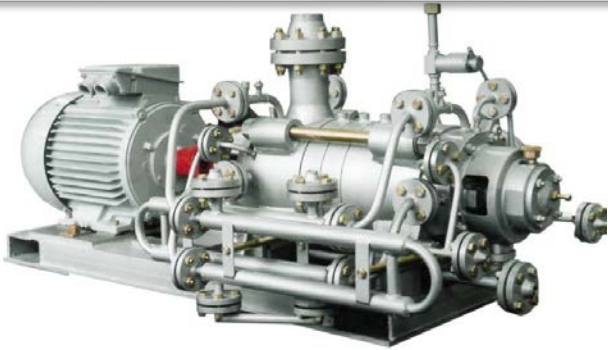

Electric and Diesel Pumps



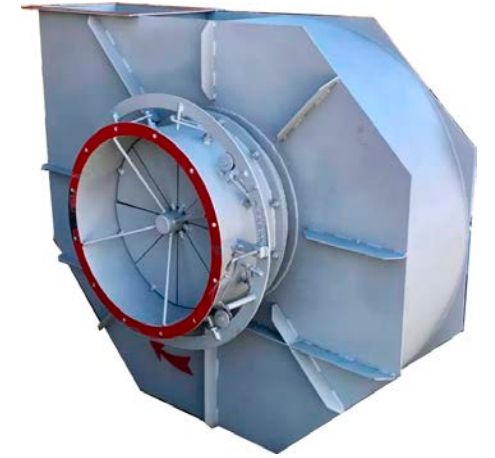

Compressors, Exhausters, Supercharges and Fans



Pipe fittings, armatures 1



Pipe fittings, armatures 2

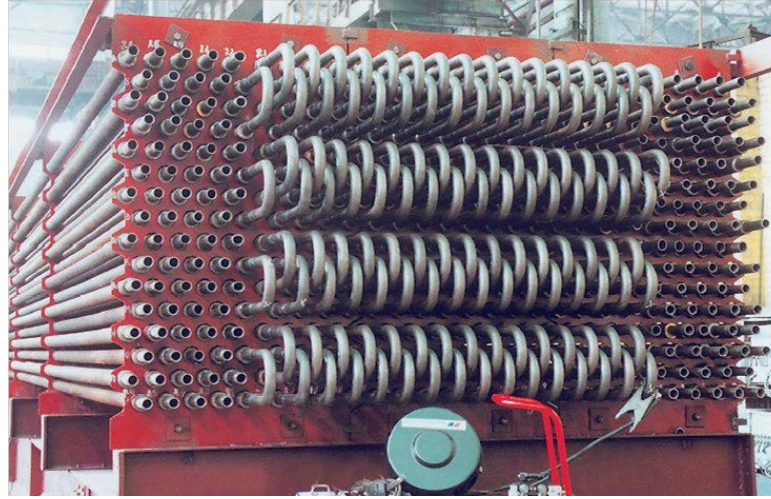

Boilers, heat exchangers



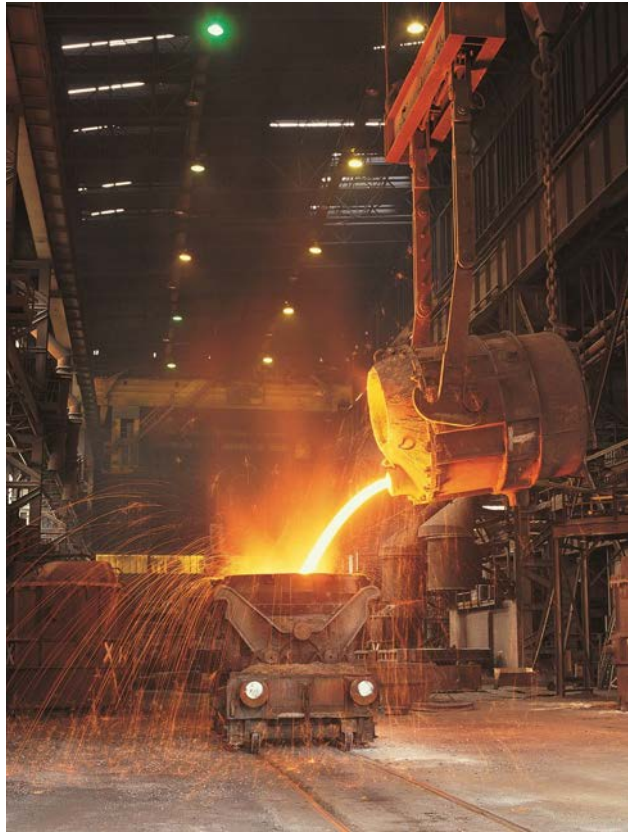

Forgings, castings



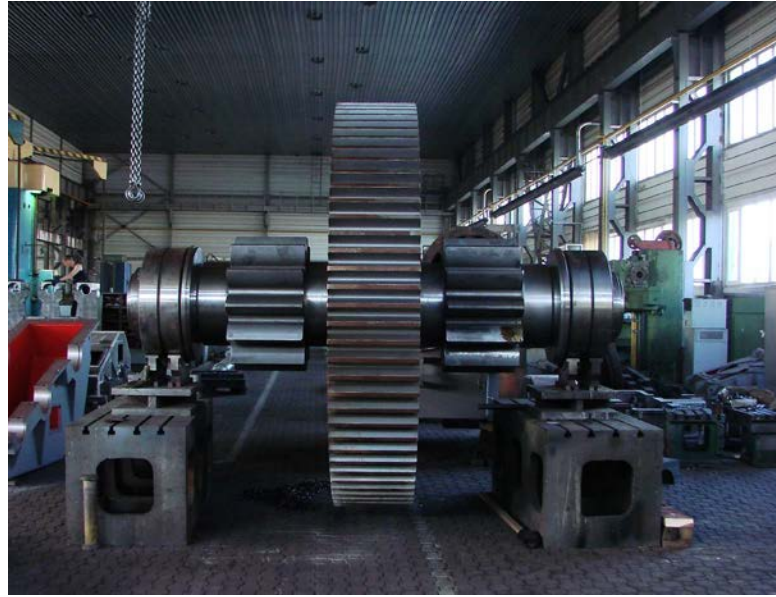

Gearboxes, Reducers, Bearings

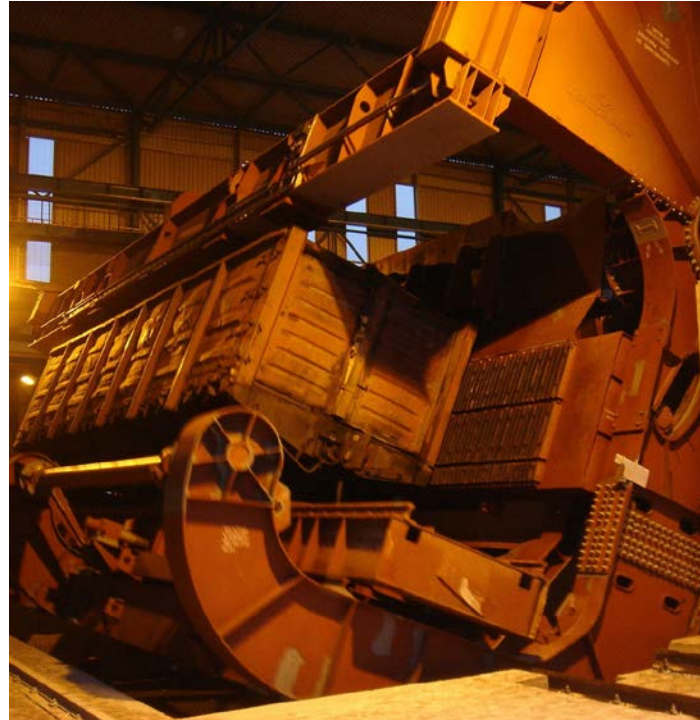

Mining equipment





Metallurgical equipment



Handling Machinery

POWER & ELECTRICAL EQUIPMENT

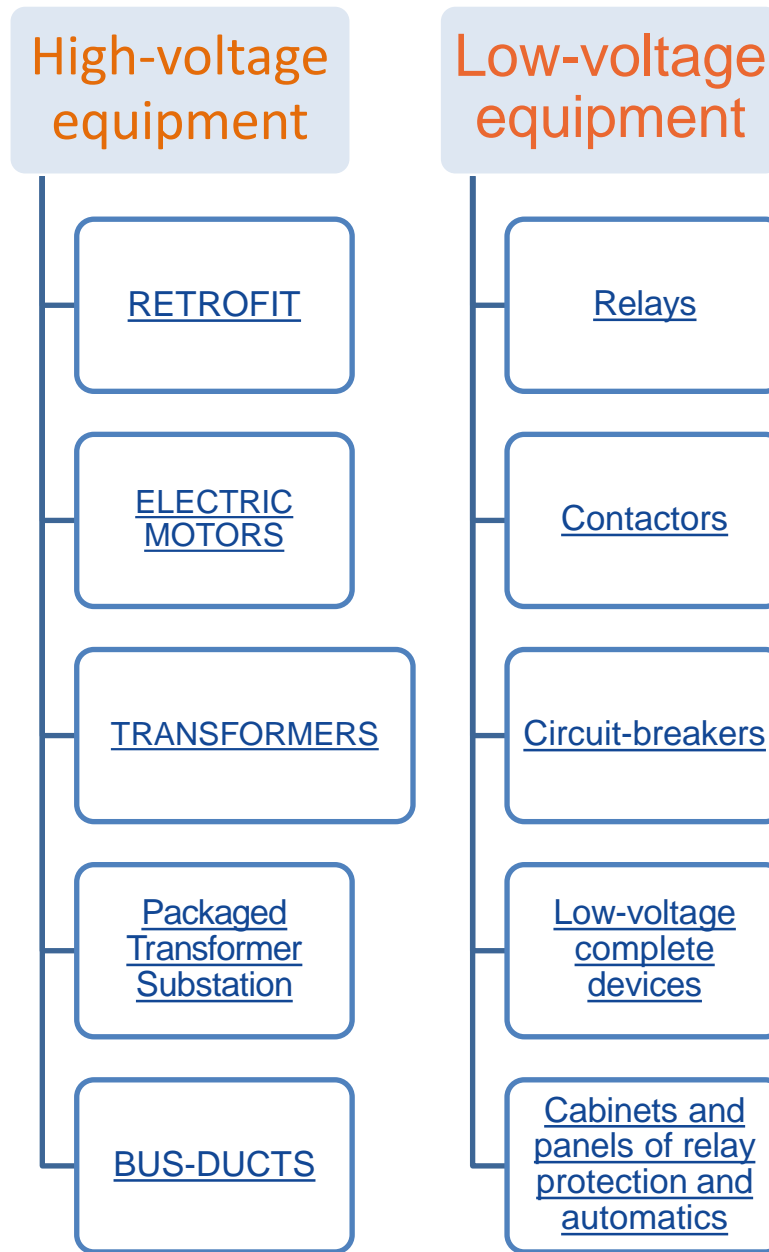

Relays, contactors

- Relay protection and automation, relay control, etc.;
- Microprocessor;
- Contactors and switches;
- Automatic circuit-breakers for currents from 40 A to 6300 A;
- Blocks, kits and devices of relay protection and automation;
- Low-voltage complete devices;
- Cabinets and panels of relay protection and automatics of the substation equipment 6-35 kV and 110-220 kV;

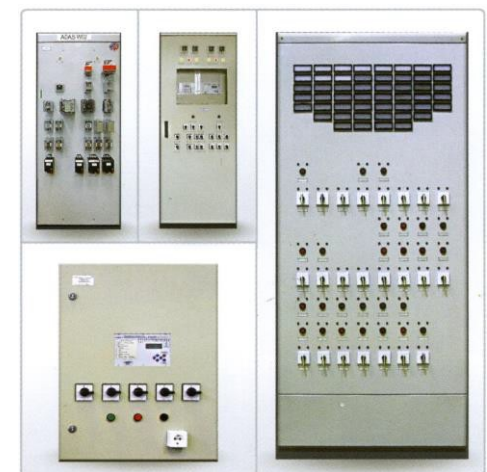



RETROFIT

RETROFIT Project involves replacement of outdate communication apparatus with service time



longer than nominal by vacuum circuit- breakers of BP series.



Some elements of the switchgear, like enclosures, mechanisms of earthing switches, disconnectors, section busbars, etc. stay the same.



RETROFIT costs 30 % of new switchgear cubicle cost



Minimum maintenance cost

ELECTRIC MOTORS

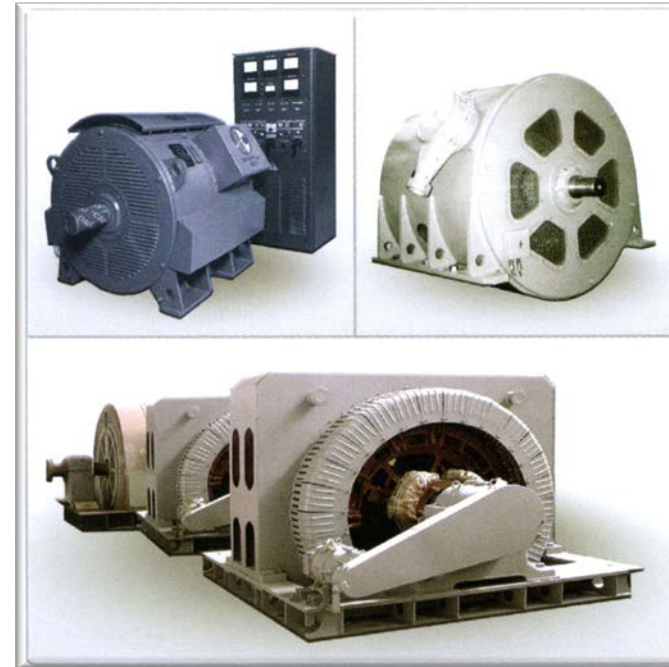
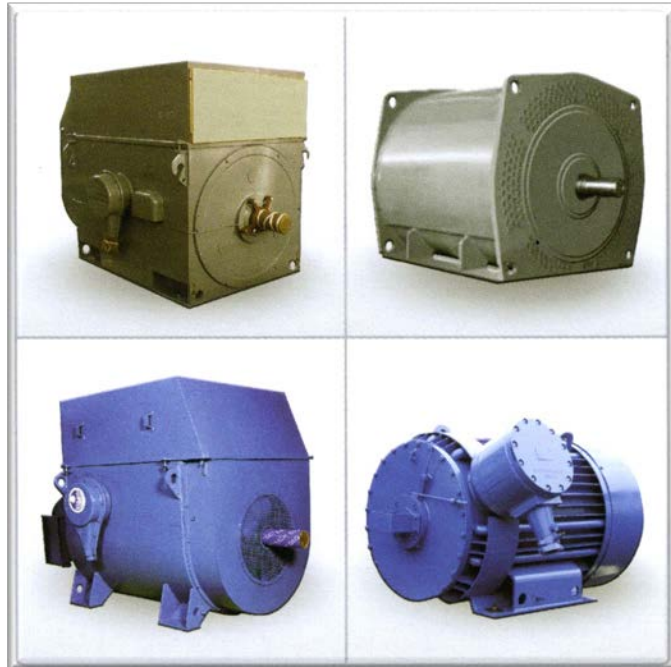

TRANSFORMERS

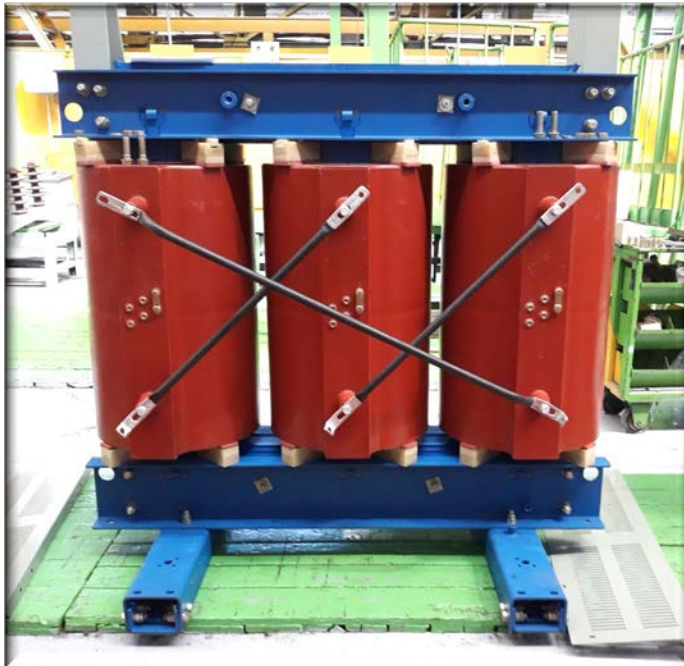

Packaged Transformer Substation

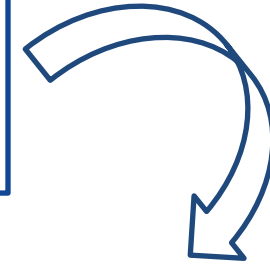

- Package transformer substations for urban networks;
- Package transformer substations for the industry;
- Package transformer substations modular type;
- Package transformer substations for the oil and gas industry;
- Package transformer substations for renewable energy sources (solar and wind power)



BUS-DUCTS

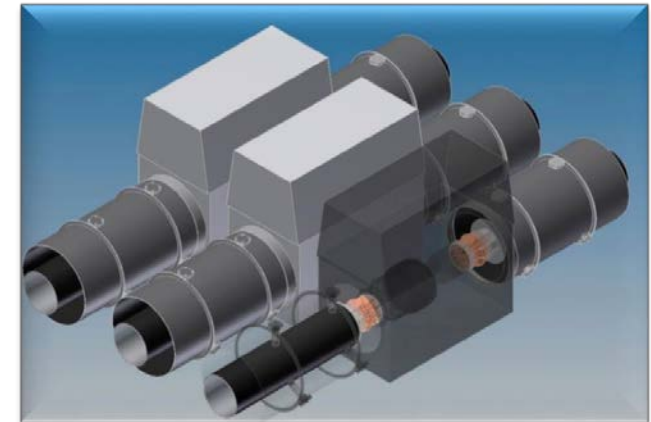
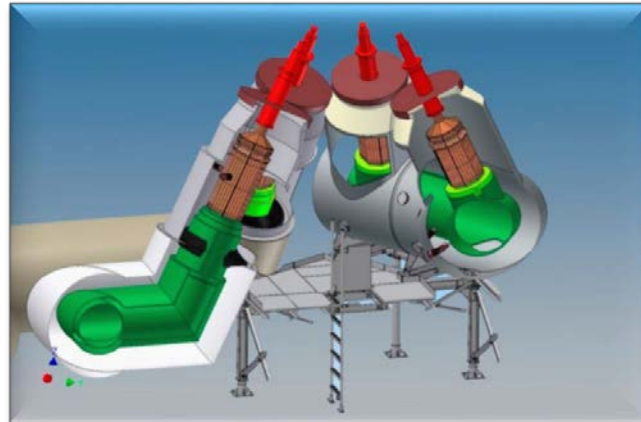

OUR PARTNERS

- "Large Electric Machines Plant" (JSC "LEMP", Novaya Kahovka, Ukraine)
 - "Rovensky plant of high-voltage equipment" (RPHE, Ukraine)
 - "Kharkov Electrical Machinery Plant" (Khemz , Kharkiv, Ukraine)
 - "JSC Poltava Turbomechanical Plant" (Ukraine)
 - "RITZ Instrument Transformers" (Germany)
 - "EGE spol. s r.o" (Czech Republic)
 - "Coil Innovation" (Austria)
 - "Uzbekchimmash Plant" (Uzbekistan)
- 

OUR CUSTOMERS

- BHILAI Steel Plant, Bhilai, India
 - Bokaro Steel Plant, India
 - Durgapur Steel Plant, India
 - Rourkela Steel Plant, India
 - Visakhapatnam Steel Plant, India
 - Bokaro Power Supply Co.(P).LTD, Bokaro
 - NTPC Kahalgaon (India)
 - NTPC Vindhyachal, India
 - BHEL Hardwar, India
 - Mahanadi Coalfields, India
 - Ordnance Factory Ambajari , Nagpur, India
 - M/s Ascon Controls, Kolkata, India
 - Meditron, Ranchi, India
 - Nelco Mahape, Mumbai, India
 - S.P. Equipment, Kota, India
 - Heavy Engineering Corporation Ltd, Ranchi, India
 - Tabani Company, Karachi, Pakistan
 - Elhakim Engineering & Agencies , Cairo, Egypt
 - Sino-Promotion, Peking, China
 - Beijing Bai Fu, China
- 

OUR CUSTOMERS IN UKRAINE

- "DTEK Kyiv GRIDS Private joint-stock company"
 - Private joint stock company "KIROVOGRADOBLENERGO"
 - Joint stock company "KHERSONOUBLENERGO"
 - Private joint stock company "RIVNEOUBLENERGO"
 - Joint stock company national nuclear energy generating company "ENERGOATOM"
 - Private joint stock company national power company "UKRENERGO"
 - Joint stock company "VINNITSAOUBLENERGO"
 - "DTEK Odesa GRIDS Joint-stock company"
 - Joint stock company "CHERNIVSYOUBLENERGO"
 - Limited liability company "DTEK "
 - Joint stock company "ZHITOMIROUBLENERGO"
- 

Thank you for your attention!

“Firm “RELAYEXPORT” Ltd.

Address: 4L, Sikorsko ho str. Kyiv, Ukraine

Tel. +380 44 373-68-70; +380 44 373-68-71

Fax: +380 44 373-68-77

E-mail: info@relayexport.com

<http://relayexport.com>